

● Specifications

Nominal Voltage		12V
Rated capacity (10 hour rate)		200Ah
Dimensions	Length	522 ± 2mm(20.55inch)
	Width	238 ± 2mm(9.37inch)
	Height	218 ± 2mm(8.58inch)
	Total Height	222 ± 2mm(8.74inch)
Approx. Weight		62.5kg(137.8lbs) ± 3%

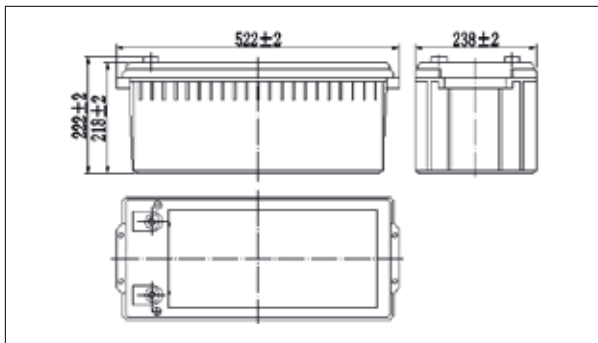

● Outer dimensions (mm)



● Terminal Type (mm)

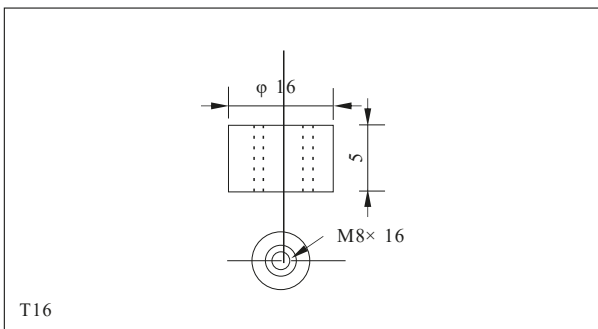

● Characteristics

Capacity (25 °C)	10HR(10.8V)	200Ah
	3HR(10.8V)	150Ah
	1HR(10.5V)	110Ah
Terminal type		T16
Internal resistance (Fully charged, 25 °C)		Approx. 3.3m Ω
Capacity affected by temperature (10HR)	40 °C	102%
	25 °C	100%
	0 °C	85%
	-15 °C	65%
Self-discharge (25 °C)	3 months	Remaining Capacity: 91%
	6 months	Remaining Capacity: 82%
	12 month	Remaining Capacity: 65%
Nominal operating temperature		25 °C ± 3°C (77 °F ± 5°F)
Operating temperature range	Discharge	-15 °C ~ 50 °C (5 °F ~ 122 °F)
	Charge	-10 °C ~ 50 °C (14 °F ~ 122 °F)
	Storage	-20 °C ~ 50 °C (-4 °F ~ 122 °F)
Float charging voltage (25 °C)		13.50 to 13.80V Temperature compensation: -18mV/°C
Cyclic charging voltage (25 °C)		14.40 to 14.70V Temperature compensation: -30mV/°C
Maximum charging current		40A
Maximum discharge current		1400A (5 sec.)
Designed floating life (20 °C)		12 years

● Construction

Component	Positive plate	Negative plate	Container	Cover	Separator	Electrolyte	Safety valve	Terminal
Raw material	Lead dioxide	Lead	ABS	ABS	AGM	GSA Gel	Rubber	Copper

● Constant Current Discharge Characteristics Unit: A (25 °C, 77 °F)

F.V/Time	15 min	30min	60min	2h	3h	4h	5h	6h	8h	10h	20h
9.60V	320	194	120	73.1	52.0	40.8	34.7	30.6	24.5	20.4	10.8
9.90V	312	190	118	72.6	51.7	40.6	34.5	30.4	24.3	20.3	10.8
10.2V	301	184	115	72.0	51.4	40.3	34.2	30.2	24.2	20.3	10.7
10.5V	291	180	112	70.9	51.0	40.0	34.0	30.0	24.0	20.1	10.7
10.8V	275	173	108	69.1	50.0	38.8	33.0	29.1	23.3	20.0	10.6

● Constant Power Discharge Characteristics Unit: W (25 °C, 77 °F)

F.V/Time	15min	30min	60min	2h	3h	4h	5h	6h	8h	10h	20h
9.60V	3514	2177	1368	846	612	480	410	362	291	243	129
9.90V	3429	2133	1347	841	608	477	408	360	289	243	129
10.2V	3303	2068	1313	834	604	474	405	357	287	242	129
10.5V	3190	2018	1272	821	600	470	402	355	285	240	128
10.8V	3022	1944	1231	800	588	456	390	344	277	239	127

Note: The above characteristics data can be obtained within three charge or discharge cycles.

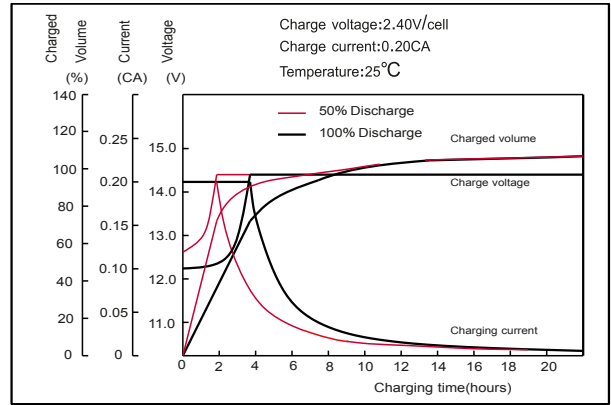
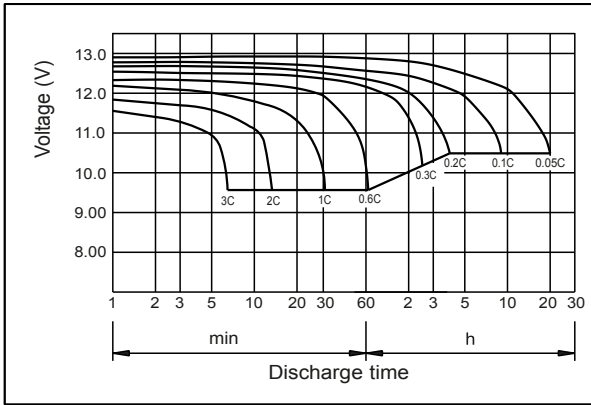

● Temperature effects on Capacity

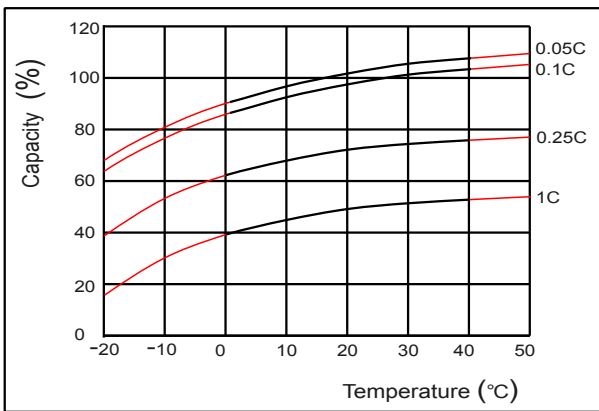

● Self-discharge characteristics

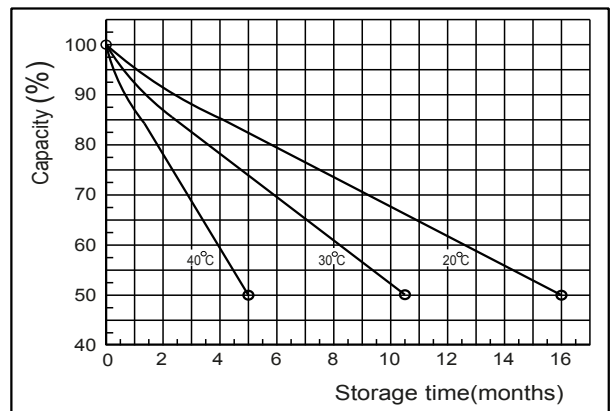

● Floating life on Temperature

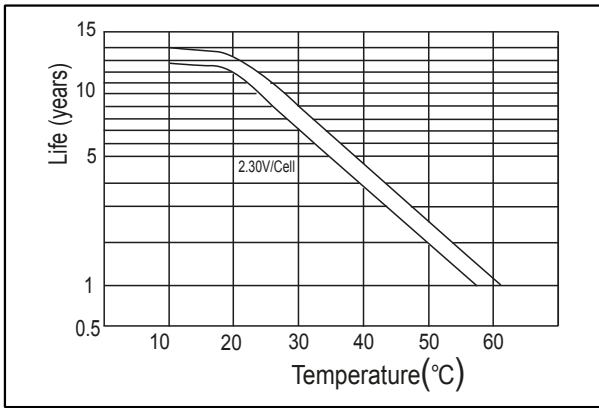

● Cycle life on D.O.D (25°C)

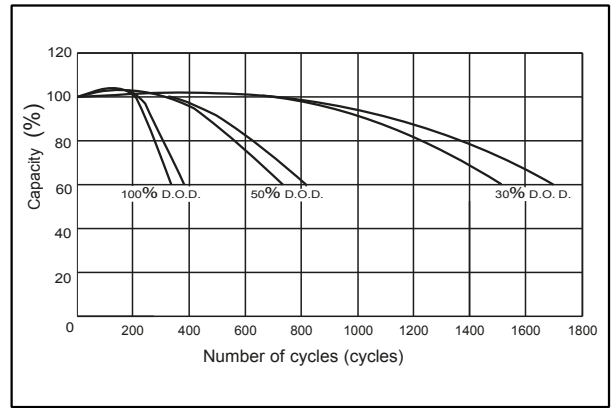

● The relationship for OCV and Capacity (25°C)

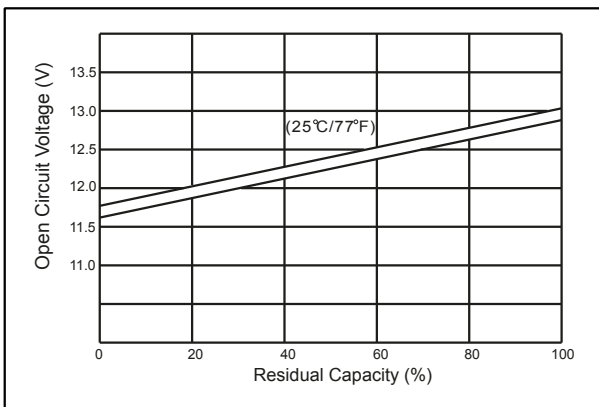

● The relationship for Charging voltage and Temperature

