

TOPCON,N-TYPE MONO MODULE

MX-M10-M-27-MH
(555-575)

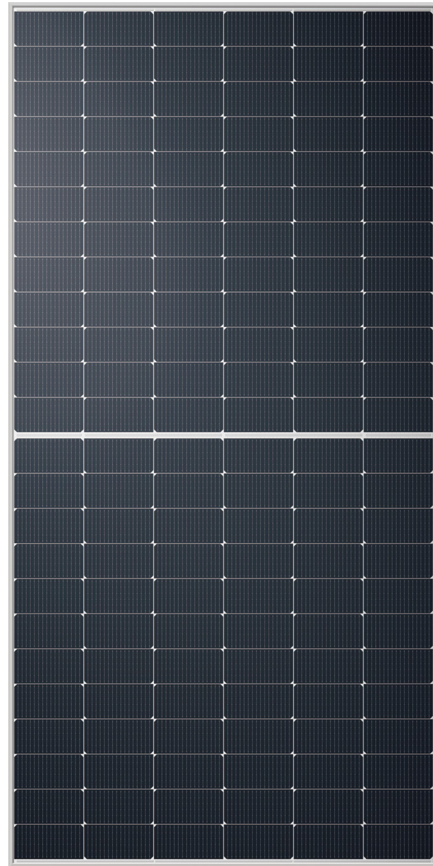

High conversion efficiency
High module efficiency to guarantee power output.



0 to +5W positive tolerance
Detailed information in Electrical Specifications.



Self-cleaning glass
Coating glass for self-cleaning, reduce surface dust.



48-hour response service



Outstanding low irradiation performance
Excellent module efficiency even in the weak light conditions, such as morning or cloudy.

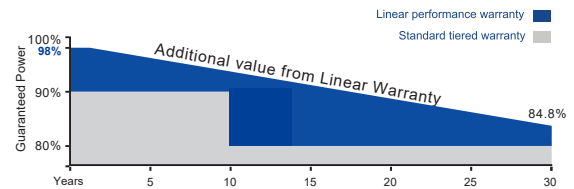

Excellent loading capability
2400Pa wind loads, 5400Pa snow loads.

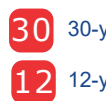

30-year performance warranty

12-year warranty on materials and workmanship

IEC 61215 Ed.2
IEC 61730
UL 1703



ELECTRICAL DATA

Model Type (MX-M10-M-27-MH-***W)	555	560	565	570	575
Peak Power (Pmax)	555W	560W	565W	570W	575W
Module Efficiency	21.5%	21.7%	21.9%	22.1%	22.3%
Maximum Power Voltage (Vmp)	43.64V	41.80V	41.95V	42.10V	42.25V
Maximum Power Current (Imp)	13.33A	13.40A	13.47A	13.54A	13.61A
Open Circuit Voltage (Voc)	50.35V	50.47V	50.60V	50.74V	50.88V
Short Circuit Current (Isc)	14.05A	14.13A	14.21A	14.29A	14.37A
Power Tolerance			0 to +5W		
Maximum System Voltage			1500V		
Nominal Operating Cell Temperature			45±2°C		
Maximum Series Fuse Rating			25A		

MECHANICAL DATA

Cell Type	182mm, TOPCon
Number of Cells	144(12×6×2)
Weight	26.4kg
Dimension	2278x1134x35mm
Max Load	5400 Pascals
Junction Box	IP68 rated
Connector	MC4 Compatible
Wire Type	PV Wire

TEMPERATURE CHARACTERISTICS

Temp. Coeff. of Isc (TK Isc)	+0.046% /°C
Temp. Coeff. of Voc (TK Voc)	-0.250% /°C
Temp. Coeff. of Pmax (TK Pmax)	-0.300% /°C

PACKING MANNER

Container	40' HQ
Pieces per Pallet	31
Pieces per Container	620

PHYSICAL CHARACTERISTICS

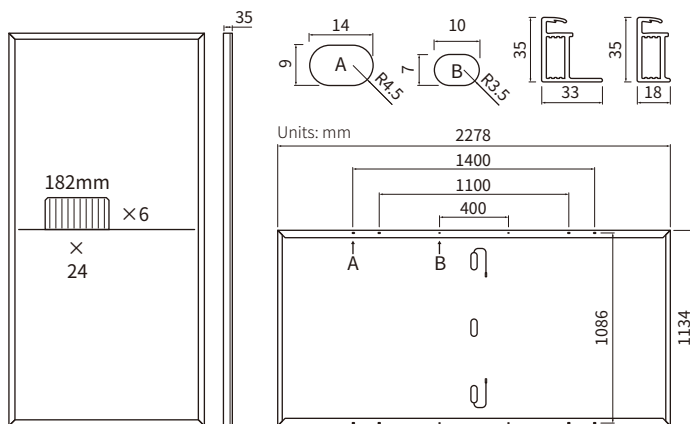

ELECTRICAL CHARACTERISTICS

MX-M10-M-27-MH-575W

Current - Voltage Curve

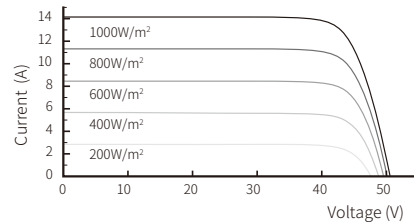

Power - Voltage Curve

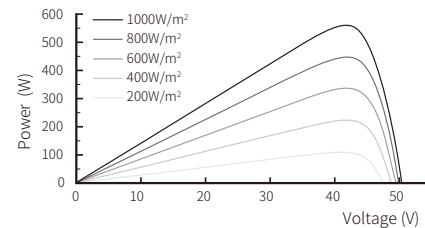

Current - Voltage Curve

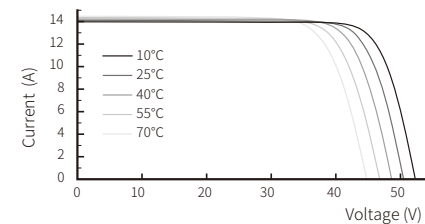

Note: the specifications are obtained under the Standard Test Conditions (STCs): 1000W/m² solar irradiance, 1.5 Air Mass, and cell temperature of 25°C. The NOCT is obtained under the Test Conditions: 800W/m², 20°C ambient temperature, 1m/s wind speed, AM 1.5 spectrum.